

The Genuine. The Original.



LOADING DOCK SOLUTIONS



DOCK WITH EASE  
Load with Confidence

---

**SAFE Features.  
SMART Designs.  
SMOOTH Transitions.**

At Overhead Door™, we've made loading dock operations smarter, safer, and more straightforward.

Designed with both installers and operators in mind, our products stand out with industry-leading features for unmatched quality. And as your direct source for equipment, service, and solutions, you can trust Overhead Door™ to help your facility run smoothly now and into the future.

**Extended  
WARRANTY**

when dock and door are  
purchased together.

**1-Year Limited Warranty.**

Warranty on dock equipment extends to **2-year limited when paired and purchased with the door.**



# SAFETY MATTERS

Safety in and around the loading dock is critical, not just for compliance, but for protecting workers, products, and equipment. Almost 25% of all industrial accidents take place at the dock, where constant forklift traffic, uneven surfaces, and heavy machinery create daily risks that can lead to injury, downtime, and damage. Between 2015 and 2020, more than 33,000 employees missed work due to injuries on docks, dock plates, and ramps, according to the Bureau of Labor Statistics.

In fact, the 2025 Travelers Injury Impact Report found that overexertion (37%), slips, trips and falls (23%), and struck-by accidents (12%) are among the most common causes of injury in wholesale, many of which can happen around the dock. Over time, these stresses add up. Prioritizing a smoother, more secure dock experience can help prevent problems before they start.

## KEY SAFETY CONSIDERATIONS:

- Minimizing vibration and impact to reduce strain on workers and equipment
- Protecting employees from fall hazards at dock edges and during loading
- Reducing long-term injury risks by improving daily operating conditions
- Using proper support systems when equipment is raised for maintenance

**OUR LOADING DOCK SOLUTIONS CAN HELP.**

# TOTAL SOLUTIONS PARTNER

Overhead Door™ is the go-to partner when architects, contractors, and facility pros need reliable door and dock solutions done right. As your single-source provider, we simplify every step, from design and specifications to installation and support. Our systems are built to work together, cutting jobsite headaches, speeding up timelines, and boosting performance. With extended warranties and fast access to parts and service, we help you deliver lasting value confidently and efficiently.

## **DOOR AND DOCK SOLUTIONS.**

Broadest range of equipment solutions in the industry.

## **BUNDLED ADVANTAGES.**

Optimize project pricing and receive extended warranty when dock leveler and commercial door are purchased together.

## **DEDICATED DISTRIBUTION.**

Expert installation and service from local partners ready to help.

## **A NAME YOU CAN TRUST.**

Most recognized, most specified, most trusted brand for over a hundred years.

## **ONE SOURCE FROM DESIGN TO INSTALL.**

Offering architect services, exclusive manufacturing support, OEM parts, a wide-range of durable, quality products, and knowledgeable technical support and installation through our large network of dedicated Overhead Door™ distributors.





# HYDRAULIC DOCK LEVELER

OVERHEAD DOOR™

## SPECIFICATIONS

### DIMENSIONS/CAPACITY/APPLICATION

Model H68R	6' wide x 8' length
Model H78R	7' wide x 8' length
Weight Capacity	30,000, 35,000, 40,000, 45,000 lbs CIR
Ideal Application	High-volume, fast-paced docks
Option	24" Pit Adaptation Kit

### BUMPER BOXES STANDARD

Molded Rubber Bumpers	√ Standard
Laminated Bumpers & Steel Faced Bumpers	Optional

### CONTROL

Control Panel (Single Button)	√ Standard
-------------------------------	------------

### LIP

16" Lip	√ Standard
18" & 20" Lip	Optional
Lip Keepers & Lip Bevel	√ Standard
Lip Taper	√ Standard (Model H78R Only)

### OPERATION

End Loading & Below Dock Capable	√ Standard
Hydraulic Pump: 3 Phase 208V, 240V, 480V	Optional
Hydraulic Pump: Single Phase 120V, 208V, 240V	Optional

### SAFETY

Tethered Maintenance Brace	√ Standard
Safety Tread on Deck & Lip	√ Standard
Velocity Safety Fuse	√ Standard
Toe Guards: Working Range (12" Above/Below Dock)	√ Standard
Toe Guards: Full Operating Range	√ Standard

### WEATHER SEALS

Weather Seal: Brush or Neoprene	Optional
---------------------------------	----------



#### 1-Year Limited Warranty.

Warranty on dock equipment extends to **2-year limited when paired and purchased with the door.**

## SAFE Features.

Designed with safety at the forefront, the Overhead Door™ hydraulic dock leveler features an open pit base frame providing clear access for safer installation, easier cleaning, and streamlined maintenance—protecting crews and preserving uptime.

- Targeted shimming reduces setup effort and enhances safety



1

**Patent-pending textured powder coat** delivers unmatched slip resistance and preserves finish in high-traffic environments



2

**Open lug hinge design** sheds debris and requires minimal lubrication, keeping lip and deck movement smooth and maintenance simple

## SMOOTH Transitions.

Built to perform under pressure, the Overhead Door™ hydraulic dock leveler consistently delivers on smooth, secure transfers year after year—maximizing operational efficiency.

- Meets ANSI MH30.1-2022 standards for strength and durability—proven to support a 10-year structural life



3

**34% weld coverage** between beam and deck offer industry-leading reinforcement for long-term reliability



4

**Standard 3-wheel fork truck support** expands application versatility—ready for diverse loading demands

## SMART Designs.

Thoughtful engineering—like four steel fork loops to improve stability and prevent sliding when stacked for transport—speeds up install time, simplifies upkeep, and reduces service calls.

- Top side adjusters quickly align the deck with the building floor for a faster install
- Full-width rear deck hinge enhances structural integrity



5

**Unique fillet welds** create a stronger bond to pit steel and speed up installation—reducing labor time without compromising structural integrity



6

**Working range toe guards** are easily replaced without welding—simplifying service and minimizing downtime

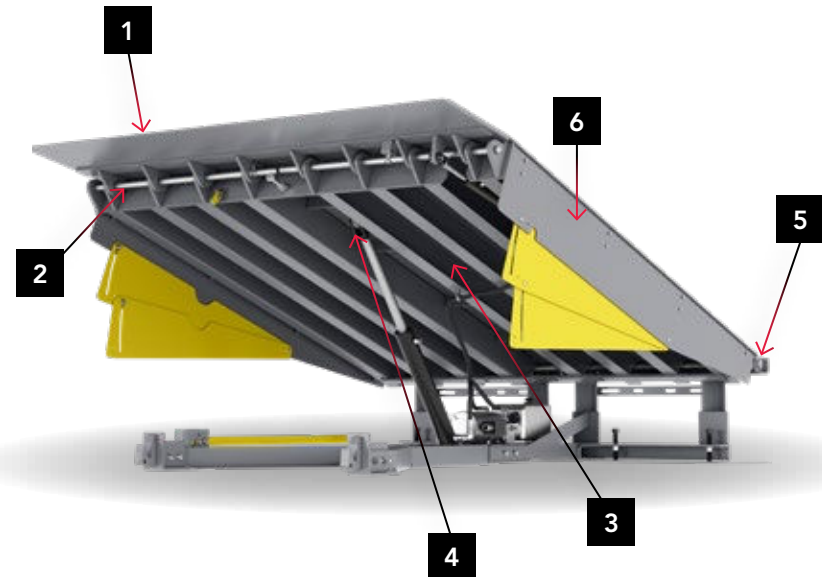

# MECHANICAL DOCK LEVELER

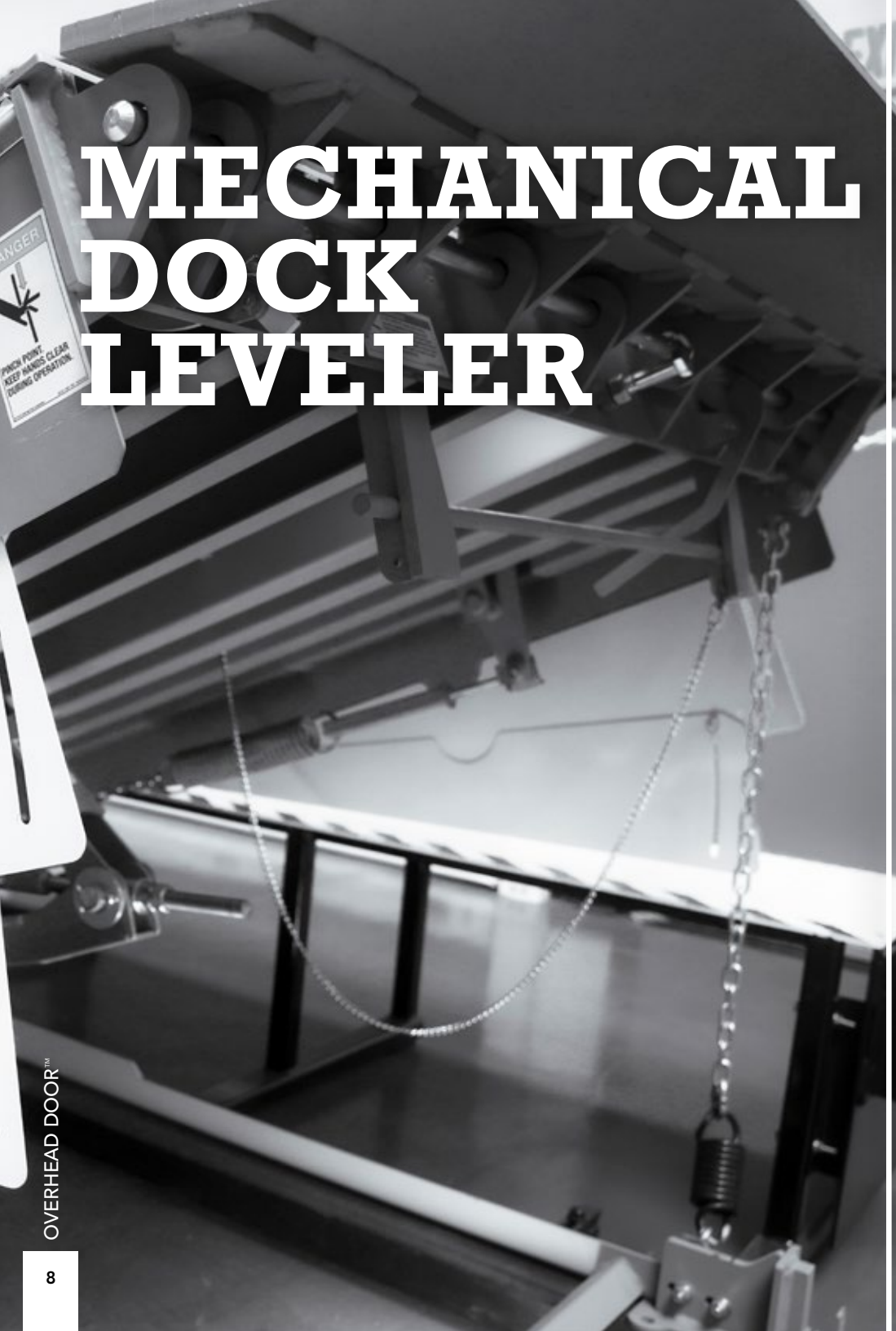

OVERHEAD DOOR™

## SPECIFICATIONS

### DIMENSIONS/CAPACITY/APPLICATION

Model M68R	6' wide x 8' length
Model M78R	7' wide x 8' length
Weight Capacity	30,000, 35,000, 40,000, 45,000lbs CIR
Ideal Application	Moderate traffic, budget-conscious facilities
Option	24" Pit Adaptation Kit

### BUMPER BOXES STANDARD

Molded Rubber Bumpers	√ Standard
Laminated Bumpers & Steel Faced Bumpers	Optional

### CONTROL

Hold Down Auto Release	√ Standard
------------------------	------------

### LIP

16" Lip	√ Standard
18" & 20" Lip	Optional
Lip Keepers & Lip Bevel	√ Standard
Lip Taper	√ Standard (Model M78R Only)

### OPERATION

End Loading & Below Dock Capable	√ Standard
----------------------------------	------------

### SAFETY

Tethered Maintenance Brace	√ Standard
Safety Tread on Deck & Lip	√ Standard
Safety Legs	√ Standard
Toe Guards: Working Range (12" Above/Below Dock)	√ Standard
Toe Guards: Full Operating Range	Optional

### WEATHER SEALS

Weather Seal: Brush or Neoprene	Optional
Chain Hole Seal	Optional



**1-Year Limited Warranty.**

Warranty on dock equipment extends to **2-year limited when paired and purchased with the door.**

## SAFE Features.

Purpose-built with an open base frame that enhances visibility and access during install and service—reducing risk, improving ergonomics, and supporting a safer work environment from day one.

- Targeted shimming reduces setup effort and enhances safety

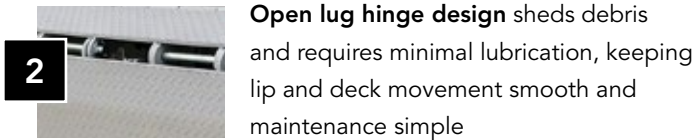
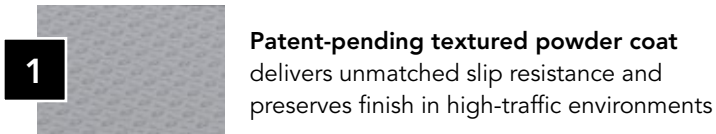

## SMOOTH Transitions.

Durable, dependable, and performance-tested to ensure consistent dock-to-trailer transfers that safeguard people, product, and profitability.

- Meets ANSI MH30.1-2022 standards for strength and durability—proven to support a 10-year structural life

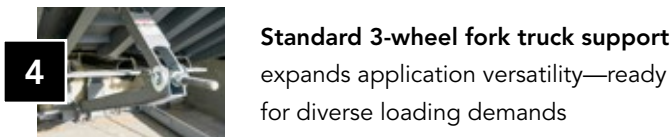
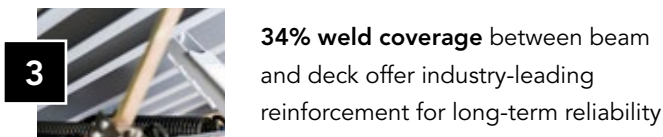

## SMART Designs.

Precision-built with intuitive features—like four steel fork loops to reduce damage and shifting during shipping—that streamline setup, reduce service demands, and keep operations running with minimal intervention.

- Top side adjusters quickly align the deck with the building floor for a faster install
- Full-width rear deck hinge enhances structural integrity

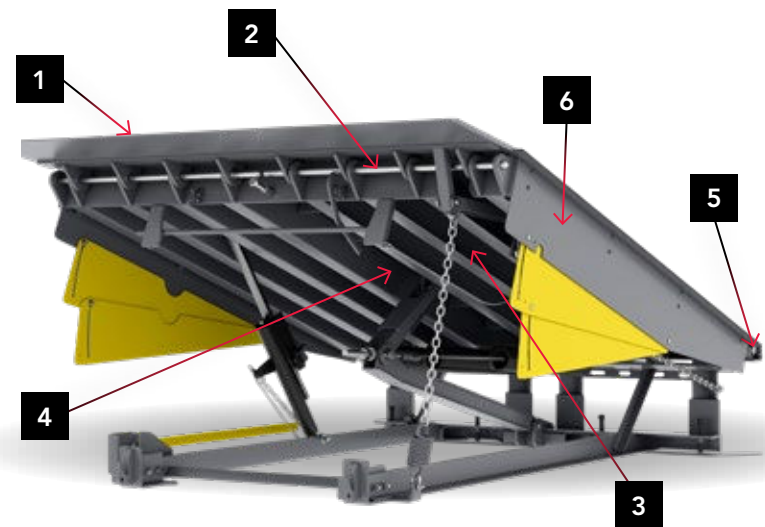
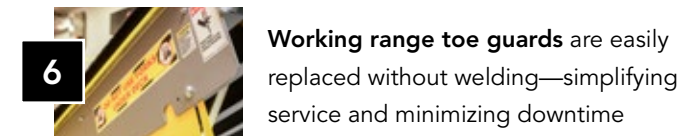
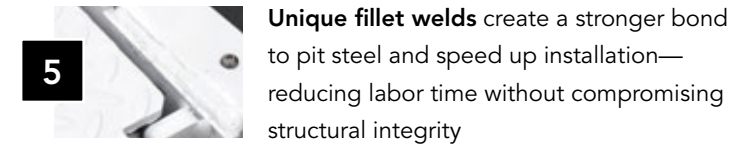

# EDGE OF DOCK LEVELER

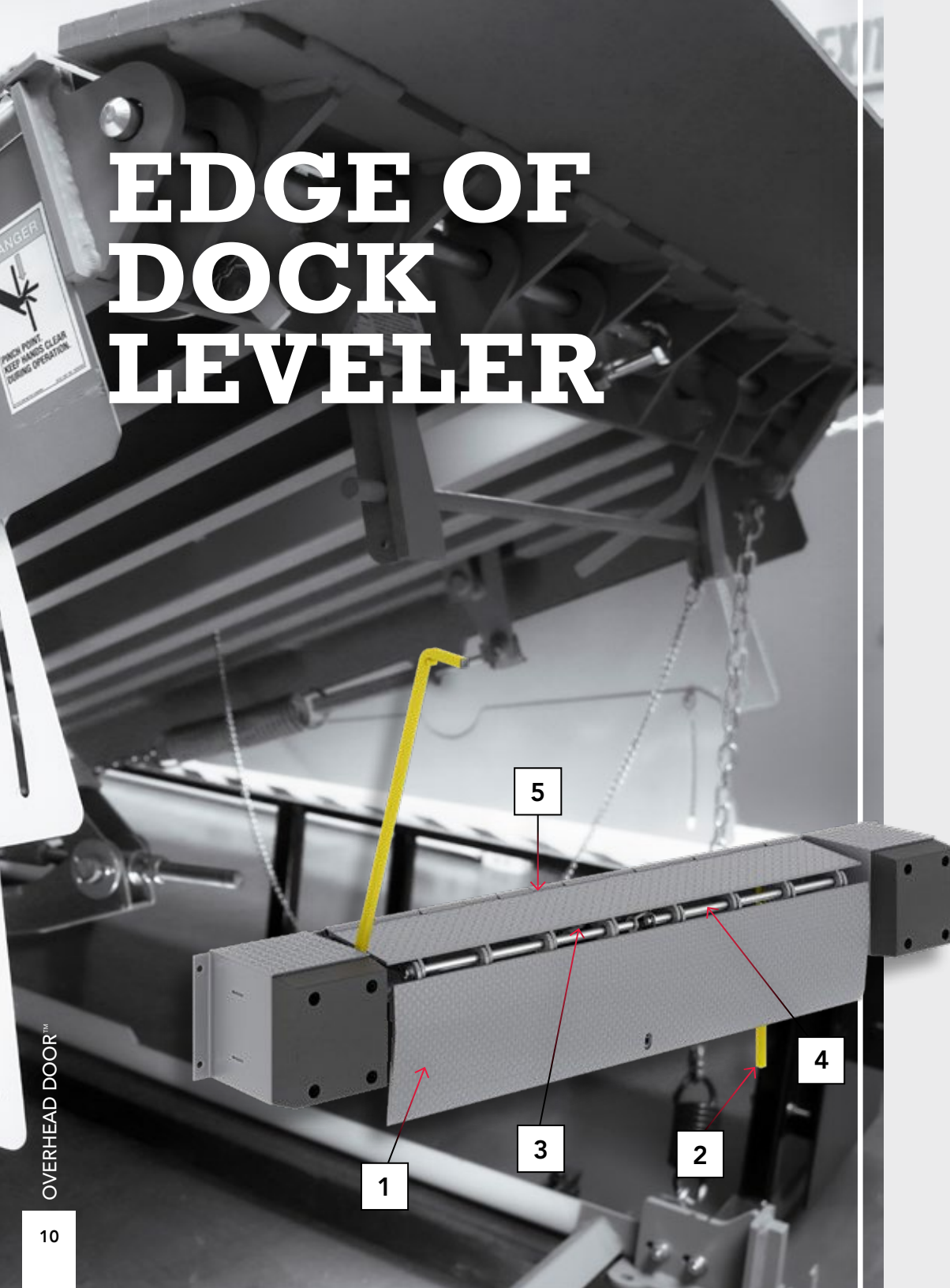

## SPECIFICATIONS

### DIMENSIONS/CAPACITY/APPLICATION

Model E66R	66"
Model E72R	72"
Weight Capacity	20,000, 30,000 lbs CIR
Ideal Application	Captive fleet, cost-effective reliability

### BUMPER BOXES STANDARD

Molded Rubber Bumpers	√ Standard
Laminated Rubber Bumpers	Optional
Steel Faced Bumpers	Optional

### LIP

15" Lip (Choose: Reg, Mid, High, Flat Crown)	√ Standard
17" Lip	Optional
Lip Bevel	√ Standard
Stepped Overreach Lip	Optional

### OPERATION

Operating Range 5" Above/Below Dock	√ Standard
Working Range 3" Above/Below Dock	√ Standard
Auto Return to Store	√ Standard
Self Storing Handle	√ Standard

### SAFETY

Tethered Maintenance Brace	√ Standard
Safety Tread on Deck & Lip	√ Standard



### 1-Year Limited Warranty.

Warranty on dock equipment extends to **2-year limited** when paired and purchased with the door.

## SAFE Features.

Engineered with integrated bumpers, ergonomic lift mechanisms, and accessible service points to support safer installation, operation, and upkeep.

- Returns to stored position in event truck pulls away

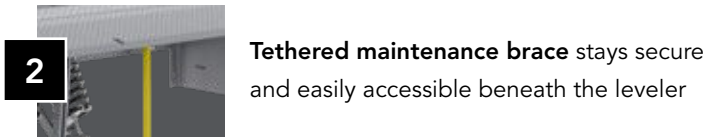
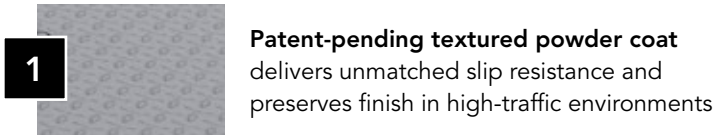

## SMOOTH Transitions.

Heavy-duty construction and precision-machined lip deliver consistent, secure trailer engagement—protecting crews, cargo, and bottom lines.

- Meets ANSI MH30.1-2022 standards for strength and durability—proven to support a 10-year structural life
- Quick and easy-to-use handle with built-in storage and tether to prevent loss

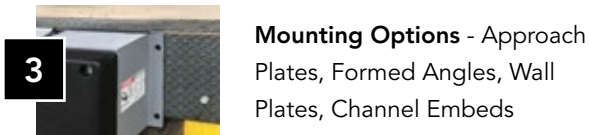

## SMART Designs.

Compact, bolt-on design with pre-mounted components simplifies install and minimizes maintenance—ideal for fast-paced dock environments.

- Environmental Compliance - U.S. EPA recommended eco-friendly coating process

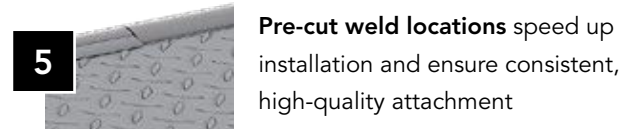
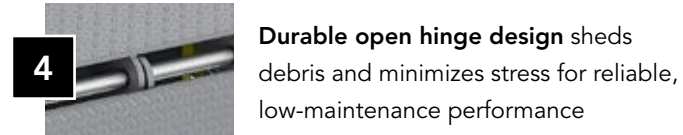

## Mounting Options:



### Approach Plates

Create a continuous trailer-to-building path that improves safety, efficiency, and protection during loading.

### Wall Plates

For vertical mounting, ensures alignment and long-lasting support.

### Formed Angles

Reinforce high-traffic, heavy-load areas to extend leveler performance.

### Channel Embeds

Seamlessly integrate with concrete for a stable, durable foundation.



# TRAILER RESTRAINTS

The Model RTP110R is a permanently mounted, electric mechanical restraint built for lasting performance and safety. Its rugged, zinc-plated construction stands up to harsh weather, while push-button controls, integrated sensors, and LED indicators ensure secure, reliable operation and clear communication at the dock.

## Options:

- 115V 1-phase for restraint with **Standard Panel Control** (additional voltage options available upon request)
- Interlock options for both stored dock leveler lip and door position communicate to system when it is safe to operate leveler or door
- **The Combo Control Panel** provides advanced functionality with the addition of a single push button dock leveler operation control
- **The Combo Plus Control Panel** includes the single button dock leveler operation control and open/close/stop button control for door operation



LIGHT ASSEMBLY



STANDARD  
CONTROL BOX



COMBO  
CONTROL BOX



COMBO PLUS  
CONTROL BOX

**1-YEAR LIMITED WARRANTY**  
covers parts and labor.

## SAFE Features.

This powered impact restraint offers enhanced safety options via dock leveler and door interlock capabilities as well as graduating control panel options.

- Restraint: Integrated position sensors are waterproof and continuously monitor the hook's position and the presence of the Rear Impact Guard (RIG) bar. Restraint hook maintains contact with the RIG bar and automatically adjusts with trailer motion
- Traffic Communication is facilitated through inside and outside red and green LED lights, providing clear status to both truck drivers and dock personnel
- An LCD display in the control panel offers real-time system monitoring. In the event the RIG bar is not detected or engaged, an audible alarm is triggered

## SMART Designs.

Eco-friendly, sustainable alternative to hydraulic systems.

- Exclusive hook position sensor means no limit switches or costly adjustments
- IP-44 rated DC gear motor protected from dirt and water spray in any direction
- Low power consumption saves on energy costs
- Unit mounts to dock wall above ground level for easy installation

## SMOOTH Transitions.

Built to perform in harsh environments, it requires virtually no maintenance.

- Zinc plating provides all-weather durability
- Pulse width modulation motor control increases life of motor and mechanical parts suffer less impact damage due to integrated shock absorption
- Low-profile 9" carriage works with all standard trailers and an impact extension bar with a service range of 9" to 25"
- Easy push button operation

# SHELTER & SEAL SOLUTIONS

Explore our innovative options for dock shelters and seals. With Overhead Door™ you are covered with weather protection, insulation and efficiency.

## FIXED DOCK SEAL

Our fixed dock seal uses compressible side columns and a top pad to create a tight seal around the trailer opening. Ideal for maximizing thermal efficiency and keeping the interior protected from external elements.

### Robust Construction

- Double-stitched seams with UV-treated polyester thread
- Premium-grade foam for consistent compression and recovery down to -40°F
- Fire-resistant foam bonded with elastic, non-flammable adhesive
- Plated vents help with moisture drainage and airflow
- Resilient fabric options
- Fire-resistant materials available in various weights, including abrasion-resistant 40 oz fabric
- All fabrics UV-treated to resist fading

### Optional Upgrades for Protection

- Wear pleats on columns for extra defense against tears and friction
- 66 oz heavy-duty pleats for added reinforcement
- Optional bottom seal pad for full 4-sided sealing (ideal for dock positions without levelers)



## ADJUSTABLE CURTAIN DOCK SEAL

This versatile dock seal combines side columns with an adjustable top curtain to accommodate trailers of varying heights. Ideal for improving weather protection and reducing energy costs.

### Flexible Curtain System

- Up to 60" adjustable drop
- Full-width steel tube supports curtain and prevents sagging
- Curtain height adjusts via rope and pulley for better sealing and energy control
- Optional PVC strip curtains for cold weather environments

### Premium Construction Quality

- UV-treated, high-strength polyester thread for long-lasting seams
- Premium-grade foam maintains performance in temperatures as low as -40°F
- Fire-resistant foam bonded with a flexible, non-flammable adhesive
- Vented columns support airflow and moisture drainage

### Durable Fabric Selection

- Fire-resistant fabrics in multiple weights, including a 40 oz premium version with 6x abrasion resistance
- UV-treated to prevent fading over time

### Extra Trailer Protection

- Optional wear pleats for increased abrasion resistance
- Available with reinforced 66 oz wear pleats for extra protection at critical contact points

### Optional 4-Sided Sealing

- Bottom seal pad available to create a complete seal around the trailer at docks without levelers

## FIXED DOCK SHELTER

Designed for maximum trailer accessibility and weather protection, this shelter uses flexible vertical and top panels to fit various trailer sizes. It allows full access to the back of the trailer while improving energy efficiency in your facility.

### Strong, Weather-Resistant Construction

- Galvanized steel panels with aluminum trim for a clean, durable finish
- Peaked top panel ensures proper drainage
- Double-stitched seams with UV-treated polyester thread
- Foam bead reinforcement on leading edges
- Fiberglass enclosed in multilayer pockets; provides strength and shape to vertical panels

### Superior Fabric Performance

- Fire-resistant fabric in multiple weight options
- Premium 40 oz fabric offers 6x the abrasion resistance of standard material
- Premium Plus fabric (similar to industrial conveyor belts) for high-impact environments: resists UV, fire, abrasion, tearing, rot, stains, salts, and oils
- UV-treated to minimize fading
- Enhanced impact protection
- Overlapping wear pleats on upper corners guard against trailer damage and fabric wear



## FOAM DOCK SHELTER

This impactful dock shelter features L-shaped foam side columns that conform to the trailer, creating a snug seal against the elements. Adjustable top curtains and flexible construction allow it to fit a wide range of trailer sizes, while providing full access to the trailer's width and height.

### Adjustable Curtain Design

- Up to 52" curtain drop for taller trailers
- Full-width steel tube prevents curtain sagging
- Rope and pulley system adjusts curtain height to improve energy efficiency
- Optional overlapping PVC strips for cold storage applications

### Durable, High-Quality Build

- Double-stitched, UV-treated polyester thread for long-lasting seams
- Premium foam maintains compression and recovery down to -40°F
- Fire-resistant foam bonded with elastic, non-flammable adhesive for extended life
- Vented openings promote airflow and moisture drainage within columns

### Heavy-Duty Fabric Options

- Fire-resistant materials in various weights, including a 40 oz premium version with 6x more abrasion resistance
- UV protection on all fabrics to resist fading

### Added Impact Protection

- Optional wear pleats for side columns increase resistance to tearing and abrasion
- Available with 66 oz wear pleats for added reinforcement at top and bottom corners

# DOCK ACCESSORIES

## Optimize Every Dock

Equip high-traffic hubs and rugged industrial sites with dock accessories that enhance safety, comfort, and efficiency. Sourced for durability and performance, these solutions protect employees, support equipment, and keep operations running smoothly under pressure.



## TRAILER STANDS

Standard and premium trailer stands are self-leveling, easy-to-deploy stabilizing stands designed for high-traffic loading docks. Featuring gas-shock systems, large all-terrain wheels, and secure locking pins, they enhance safety and efficiency.



## TRACK GUARDS

Bright yellow 48" tall guards protect door tracks from forklift and pallet jack impacts without hindering door operation. Choose 3/16" or 1/4" steel with wall and floor mounts, or floor-only mount. Tapered top design minimizes hand-pinch risks.



## DOCK LIGHTS & FANS

Enhance dock safety with energy-efficient lights that illuminate trailer interiors. Available in single or dual-arm models with 40" reach for flexible positioning or stowaway. Durable polycarbonate housing and impact-resistant components withstand dock conditions. Optional fan attachment provides added comfort in warm environments.



## BUMPERS - PIT LEVELER AND EDGE OF DOCK

Protect dock structures with laminated bumpers made from recycled truck tires and secured with 3/4" steel bar. Anchored with 3/8" heavy-duty steel angles for durability. Available in multiple sizes and vertical styles. Optional 3/8" steel-faced bumpers offer added resistance to impact and abrasion.

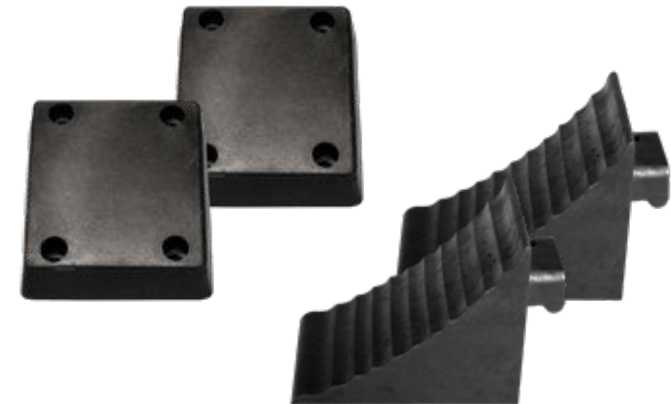

## WHEEL CHOCKS

Use two chocks per dock for optimal trailer restraint. Choose solid rubber (7" x 9" x 7") for long-lasting grip or aluminum (7" x 11" x 8") with claw base for varied surfaces. Zinc-plated chain resists corrosion and deters loss or misplacement.

# THE RIBBON™ DIFFERENCE

## LOCAL EXPERTS

Only top-tier professionals are selected to represent the Overhead Door™ brand in their communities. These local installers are known for their deep product knowledge, responsive service, and commitment to quality. When you work with an Overhead Door™ distributor, you're partnering with a trusted expert who understands your building, your timeline, and your goals.

### LOOK FOR THE RED RIBBON™

It's your guarantee of performance, professionalism, and pride—from the brand that's been setting the standard for more than 100 years.





## A PERFECT PAIR

Complement your dock with our compatible sectional warehouse doors for bundled pricing and extended warranty\* coverage.

### ANY APPLICATION

- Warehouse & Distribution
- Manufacturing
- Packaging
- Food & Beverage/Cold Storage
- Pharmaceutical
- Automotive

*\*Certain exclusions apply, see warranty for details.*

## ARCHITECT SERVICES

We provide architects with tailored assistance throughout the project lifecycle, including:

### QUICK RESPONSE TIMES

Service-level commitments to keep your design timeline on track.

### DESIGN ASSISTANCE

Product recommendations based on project needs, codes, and aesthetics.

### SPECIFICATIONS SUPPORT

CSI 3-part specs, editable content, and guidance on code compliance.

### DRAWINGS & CAD FILES

Expert installation and service from local partners ready to help.

### TECHNICAL GUIDANCE

Wind load, fire-rated, and specialty applications with engineering alignment.

### PROJECT STAGE TRACKING

We tailor support based on where your project is:

- Schematic Design (conceptual)
- Design Development
- Contract Documents
- Bidding
- Contract Administration (construction)



**INDUSTRY EXPERTS,  
DELIVERING TOTAL SOLUTIONS**

# SOLUTIONS FOR TODAY. Partner for Tomorrow.

With Overhead Door™, you get more than equipment. You get a seamless, one-stop partner. As your direct source for equipment, service, and solutions, everything we do is curated to exceed expectations and simplify the job.

---

1-800-929-DOOR • SALES@OVERHEADDOOR.COM • OVERHEADDOOR.COM

2501 S. State Hwy. 121 Bus., Suite 200, Lewisville, TX 75067



Dock Equipment



Architect's Edge